

PHASER® 850  
COLOR PRINTER  
USER GUIDE





## Phaser® 850 Color Printer User Guide

November 1999

Copyright © Tektronix, Inc. Unpublished rights reserved under the copyright laws of the United States. Contents of this publication may not be reproduced in any form without permission of Tektronix, Inc.

Tektronix®, Phaser®, PhaserShare®, ColorStix®, the TekColor® icon, and Made For Each Other® are registered trademarks of Tektronix, Inc. PhaserLink™, PhaserPort™, PhaserPrint™, PhaserSym™, PhaserTools™, TekSMART™, and the TekColor™ name are trademarks of Tektronix, Inc. TekColor Care<sup>SM</sup> and RealSUPPORT<sup>SM</sup> are service marks of Tektronix, Inc.

Adobe®, Acrobat®, Acrobat® Reader, Illustrator®, PageMaker®, Photoshop®, and PostScript®, ATM®, Adobe Garamond®, Birch®, Carta®, Mythos®, Quake®, and Tekton® are registered trademarks and Adobe Jenson™, Adobe Brilliant Screens™ technology, and IntelliSelect™ are trademarks of Adobe Systems Incorporated or its subsidiaries which may be registered in certain jurisdictions.

Apple®, LaserWriter®, LocalTalk®, Macintosh®, Mac® OS, AppleTalk®, TrueType2®, Apple Chancery®, Chicago®, Geneva®, Monaco®, and New York® are registered trademarks, and QuickDraw™ is a trademark of Apple Computer Incorporated.

Marigold™ and Oxford™ are trademarks of AlphaOmega Typography.

Avery™ is a trademark of Avery Dennison Corporation.

FTP® Software is a registered trademark of FTP Software, Incorporated.

PCL® and HP-GL® are registered trademarks of Hewlett-Packard Corporation.

Hoefer Text was designed by the Hoefer Type Foundry.

ITC Avant Guard Gothic®, ITC Bookman®, ITC Lubalin Graph®, ITC Mona Lisa®, ITC Symbol®, ITC Zapf Chancery®, and ITC Zapf Dingbats® are registered trademarks of International Typeface Corporation.

Bernhard Modern™, Clarendon™, Coronet™, Helvetica™, New Century Schoolbook™, Optima™, Palatino™, Stempel Garamond™, Times™, and Univers™ are trademarks of Linotype-Hell AG and/or its subsidiaries.

MS-DOS® and Windows® are registered trademarks of Microsoft Corporation.

Wingdings™ in TrueType® format is a product of Microsoft Corporation. WingDings is a trademark of Microsoft Corporation and TrueType is a registered trademark of Apple Computer, Inc.

Albertus™, Arial™, Gill Sans™, Joanna™, and Times New Roman™ are trademarks of Monotype Corporation.

Antique Olive® is a registered trademark of M. Olive.

Eurostile™ is a trademark of Nebiolo.

Novell® and NetWare® are registered trademarks of Novell, Incorporated.

Sun®, Sun Microsystems®, and Sun Microsystems Computer Corporation® are registered trademarks of Sun Microsystems, Incorporated. SPARC® is a registered trademark of SPARC International, Incorporated. SPARCstation™ is a trademark of SPARC

International, Incorporated, licensed exclusively to Sun Microsystems, Incorporated.

Ethernet® is a registered trademark of Xerox Corporation.

UNIX® is a registered trademark in the US and other countries, licensed exclusively through X/Open Company Limited.

Other marks are trademarks or registered trademarks of the companies with which they are associated.

PANTONE® Colors generated by the Phaser 850 Color Printer are four- and/or three-color process simulations and may not match PANTONE-identified solid color standards. Use current PANTONE Color Reference Manuals for accurate colors. PANTONE Color simulations are only obtainable on this product when driven by qualified Pantone-licensed software packages. Contact Pantone, Inc. for a current list of qualified licensees.

All trademarks noted herein are either the property of Tektronix, Inc., Pantone, Inc., or their respective companies.

© Pantone, Inc., 1988.

# Warranty

## Printer Warranty

Tektronix warrants that the Phaser 850 Printer will be free from defects in materials and workmanship for a period of one (1) year from the date of shipment. If the product proves defective during the warranty period, Tektronix, at its option, will:

- (1) repair the product by means of telephone support or on-site service at no charge for parts or labor,
- (2) replace the product with a comparable product, or
- (3) refund the amount paid for the product, less a reasonable allowance for usage, upon its return.

Under this product warranty, Customer must notify Tektronix or its authorized service representative of the defect before the expiration of the warranty period. To obtain service under this warranty, the Customer must first contact Tektronix Telephone Support personnel or that of its authorized service representative. Telephone Support personnel will work to resolve issues professionally and quickly, however the Customer must reasonably assist Tektronix or its authorized representative.

If telephone support is unsuccessful, Tektronix or its authorized service representative will provide warranty repair at Customer's site without charge as provided below.

- Service is available anywhere within the United States for products purchased in the United States
- Inside the European Economic Area, service is available within the customary on-site service area for products purchased in the EEA
- Outside the US & EEA, service is available within the customary on-site service area in the country of purchase

A description of the customary on-site service area may be obtained from the local Tektronix subsidiary or authorized Tektronix distributor. On-site service is at Tektronix or its authorized service representative's sole discretion and is considered an option of last resort.

If the Customer's product contains features that enable Tektronix or its authorized service representative to diagnose and repair problems with the product remotely, Tektronix may request that Customer allow such remote access to the product.

In the maintenance of the product, Tektronix may use new or equivalent to new parts or assemblies for equal or improved quality. All defective parts and assemblies become the property of Tektronix. Tektronix, at its option, may request the return of these parts.

## **Consumables Warranty**

Tektronix warrants that the Customer Replaceable Consumables (CRCs) will be free from defects in materials and workmanship for a period of ninety (90) days (six (6) months where longer periods are required by law) from the date of installation, but not more than one (1) year from date of shipment. Under this warranty, the Customer must notify Tektronix or its authorized service representative of the defect before the expiration of the warranty period. TEKTRONIX MAY REQUIRE THAT THE DEFECTIVE CRC BE RETURNED TO A DESIGNATED TEKTRONIX DEPOT OR THE TEKTRONIX REPRESENTATIVE FROM WHICH THE CRC WAS ORIGINALLY PURCHASED. Claims will be handled according to the current Tektronix procedure.

These warranties shall not apply to any defect, failure or damage caused by improper use or improper or inadequate maintenance and care. Tektronix shall not be obligated under these warranties:

- a) to repair damage resulting from attempts by personnel other than Tektronix representatives to install, repair or service the product unless directed by a Tektronix representative;
- b) to repair damage, malfunction, or degradation of performance resulting from improper use or connection to incompatible equipment or memory;
- c) to repair damage, malfunction, or degradation of performance caused by the use of non-Tektronix printer supplies or consumables or the use of Tektronix supplies not specified for use with this printer;
- d) to repair a product or CRC that has been modified or integrated with other products when the effect of such modification or integration increases the time or difficulty of servicing the product or CRC;
- e) to perform user maintenance or cleaning or to repair damage, malfunction, or degradation of performance resulting from failure to perform user maintenance and cleaning as prescribed by Tektronix in its published materials;
- f) to repair damage, malfunction, or degradation of performance resulting from use of the product in an environment not meeting the operating specifications set forth in the user manual;
- g) to repair this product after the limit of its duty cycle has been reached; all service thereafter shall be billed on a time and material basis;
- h) to replace CRCs that have been refilled, are used up, abused, misused, or tampered with in any way.

THE ABOVE WARRANTIES ARE GIVEN BY TEKTRONIX WITH RESPECT TO THIS PRODUCT AND ITS CUSTOMER REPLACEABLE CONSUMABLES IN LIEU OF ANY OTHER WARRANTIES, EXPRESS OR IMPLIED. TEKTRONIX AND ITS VENDORS DISCLAIM ANY IMPLIED WARRANTIES OF MERCHANTABILITY OR FITNESS FOR A PARTICULAR PURPOSE OR ANY SIMILAR STANDARD IMPOSED BY APPLICABLE LEGISLATION. TEKTRONIX' RESPONSIBILITY TO REPAIR, REPLACE, OR OFFER A REFUND FOR DEFECTIVE PRODUCTS AND CUSTOMER REPLACEABLE CONSUMABLES IS THE SOLE AND EXCLUSIVE REMEDY PROVIDED TO THE CUSTOMER FOR BREACH OF THESE WARRANTIES. TEKTRONIX AND ITS VENDORS WILL NOT BE LIABLE FOR ANY INDIRECT, SPECIAL, INCIDENTAL OR CONSEQUENTIAL DAMAGES (INCLUDING LOSS OF PROFITS) IRRESPECTIVE OF WHETHER TEKTRONIX OR THE VENDOR HAS ADVANCE NOTICE OF THE POSSIBILITY OF SUCH DAMAGES.

For the software warranty please see the end user license agreement included with the software.

If you are an Australian consumer, you should be aware that the Trade Practices Act 1974 and equivalent State and Territory legislation (collectively "the Acts") contain special provisions designed to protect Australian consumers. Nothing in any Tektronix warranty material excludes or limits the application of any provision of any of the Acts, where to do so would contravene the Acts or cause any part of this warranty to be void. In this warranty material, an implied condition or warranty, the exclusion of which from a contract with a "Consumer" (as defined in the Acts) would contravene any provision of the Acts or cause any part or all of this warranty to be void, is called a "Non-excludable Condition". To the full extent permitted by law, Tektronix's sole and total liability to the customer for a breach of any Non-excludable Condition (including for any consequential loss suffered by the customer) is limited, except as otherwise stated herein, to (at Tektronix' option) replacing or repairing the goods, or resupplying, or paying the cost of the resupply of, the services, in respect of which the breach occurred. Subject to the above, all conditions and warranties which would or might otherwise be implied in a Consumer contract, whether by operation of statute, inference from circumstances, industry practice or otherwise, are excluded.

# User safety summary

## **Terms in manual:**

**Caution:** Conditions that can result in damage to the product.

**Warning:** Conditions that can result in personal injury or loss of life.

**Use proper power source:** Do not operate this product from a power source that applies more than the voltage specified. To avoid fire hazard, use only the power cord specified for this product. In hospital applications, grounding reliability can only be achieved by the use of a hospital grade power cord, and the equipment is connected to an equivalent receptacle marked “hospital only” or “hospital grade.”

**Operation of product:** There are no user-serviceable parts inside the product. Avoid electric shock by contacting a qualified service technician to repair the product. Do not operate without the covers and panels properly installed. Do not operate in an atmosphere of explosive gases or flammable mixtures.

**Safety instructions:** Read all installation instructions carefully before you plug the product into a power source.

## **Terms on product:**

**CAUTION:** A personal injury hazard exists that may not be apparent. For example, a panel may cover the hazardous area. Also applies to a hazard to property including the product itself.

**DANGER:** A personal injury hazard exists in the area where you see the sign.

**Care of product:** Disconnect the power plug by pulling the plug, not the cord.

Disconnect the power plug if the power cord or plug is frayed or otherwise damaged, if you spill anything into the case, if product is exposed to any excess moisture, if product is dropped or damaged, if you suspect that the product needs servicing or repair, and whenever you clean the product.

**Ground the product:** Plug the three-wire power cord (with grounding prong) into grounded AC outlets only. For protection against electric shock, this product is classified Class I, and Type B where applicable.

**Location of product:** Place the printer in a well-ventilated area.



**Symbols as marked on product:**

DANGER high voltage:



Protective ground (earth) terminal:



Hot surface on or in the printer. Use caution to avoid personal injury:



Use caution. Refer to the manual(s) for information:



**Warning**

If the product loses the ground connection, usage of knobs and controls (and other conductive parts) can cause an electrical shock. Electrical product may be hazardous if misused.

**Warning**

For your protection, do not defeat any interlocks.

# Contents

Tektronix supplies and accessories	1
The front panel	6
Print quality modes	8
TekColor™ color corrections	9
Paper tips	10
Manual-feed printing	13
Printing on envelopes	18
Loading the Standard Paper/ Transparency Tray	23
Loading the High-Capacity Paper Tray Assembly	25
Loading the optional High-Capacity Transparency/Label Tray	27
Printing on High Resolution Photo Paper	29
Printing on labels	30
Automatic two-sided printing	32
Adding ink	36
Emptying the waste tray	38
Replacing the Maintenance Kit	40
Removing paper jams	42

Troubleshooting print quality 49

Moving the printer 55

Getting help 57

Index 61

# Tektronix supplies and accessories

To order supplies and accessories, contact your local dealer or visit the Tektronix web site:

[www.tek.com/Color\\_Printers/products/supplies.html](http://www.tek.com/Color_Printers/products/supplies.html)

Supplies

## ColorStix Ink

Item	Part Number
3 Free Black sticks	016-1831-00
5 Cyan sticks plus 2 Free Black sticks	016-1825-00
5 Magenta sticks plus 2 Free Black sticks	016-1826-00
5 Yellow sticks plus 2 Free Black sticks	016-1827-00
2 Cyan sticks plus 1 Free Black stick	016-1828-00
2 Magenta sticks plus 1 Free Black stick	016-1829-00
2 Yellow sticks plus 1 Free Black stick	016-1830-00

## Tektronix Paper

Item	Size	Description	Part Number
Premium Color Printing Paper	A/Letter (U. S.) 8.5 x 11 in.	500 sheets 24-lb. bond, 90 g/m <sup>2</sup>	016-1368-00
Premium Color Printing Paper	A4 (Metric) 210 x 297 mm	500 sheets 24-lb. bond, 90 g/m <sup>2</sup>	016-1369-00
High Resolution Photo Paper	A/Letter (U. S.) 8.5 x 11 in.	25 sheets 170 g/m <sup>2</sup>	016-1808-00
High Resolution Photo Paper	A4 (Metric) 210 x 297 mm	25 sheets 170 g/m <sup>2</sup>	016-1809-00
Premium Cover	A/Letter (U. S.) 8.5 x 11 in.	100 sheets 60-lb. cover, 160 g/m <sup>2</sup>	016-1823-00
Premium Cover	A4 (Metric) 210 x 297 mm	100 sheets 60-lb. cover, 160 g/m <sup>2</sup>	016-1824-00

### Transparencies

Item	Size	Description	Part Number
Premium	A/Letter (U. S.) 8.5 x 11 in.	50 sheets	016-1724-00
Premium	A4 (Metric Letter) 210 x 297 mm	50 sheets	016-1725-00
Standard	A/Letter (U. S.) 8.5 x 11 in.	50 sheets	016-1720-00
Standard	A4 (Metric Letter) 210 x 297 mm	50 sheets	016-1721-00

### Color Printing Labels

Size	Description	Part Number
A/Letter (U. S.) 8.5 x 11 in.	100 sheets / 30 labels per sheet (each 1 x 2-5/8 in.)	016-1812-00
A/Letter (U. S.) 8.5 x 11 in.	100 sheets / 6 labels per sheet (each 3-1/3 x 4 in.)	016-1813-00
A4 (Metric Letter) 210 x 297 mm	100 sheets / 14 labels per sheet (each 38.1 x 99.1 mm)	016-1814-00
A4 (Metric Letter) 210 x 297 mm	100 sheets / 8 labels per sheet (each 67.1 x 99.1 mm)	016-1815-00

### Maintenance Kit

Item	Part Number
Extended replacement maintenance roller and counter (Life: up to 45,000 images or two years, which ever comes first.)	016-1834-00
Standard replacement maintenance roller and counter (Life: up to 10,000 images or two years, which ever comes first.)	016-1822-00

## Replacement items

Item	Part Number
Maintenance Waste Tray (replacement)	436-0370-01
Maintenance Drawer (replacement)	436-0383-00
Rapid Release Guide	650-4153-00

## Additional memory

Features	Part Numbers
■ Improved performance	■ 64 Mbytes: ZMB64
■ Up to 256 Mbytes maximum	■ 128 Mbytes: ZMB128

The printer has two memory slots. When adding memory, you can use 64-Mbyte and 128-Mbyte DIMMs in combination.

## Trays

Size	Description	Part Number
Standard Paper/Transparency Tray	A/Letter (U. S.)	436-0330-00
Standard Paper/Transparency Tray	A4 (Metric Letter)	436-0332-00
High-Capacity Transparency/ Label Tray	A/Letter (U. S.)	436-0336-00
High-Capacity Transparency/Label Tray	A4 (Metric Letter)	436-0338-00

## Cleaning Kit

Item	Part Number
Package of 5 alcohol wipes	016-1845-00

## High-Capacity Paper Tray Assembly

Features	Part Numbers
<ul style="list-style-type: none"><li>■ Increased paper-printing capacity</li><li>■ Increased printing versatility and convenience</li><li>■ Up to two High-Capacity Paper Tray Assemblies can be used</li></ul>	<ul style="list-style-type: none"><li>■ U. S.: Z840LTA</li><li>■ Metric: Z840LTA Option 01</li></ul>

## Printer Station

Features	Part Number
<ul style="list-style-type: none"><li>■ Ergonomic surface height</li><li>■ Provides storage for supplies</li></ul>	ZCARTA

## Internal IDE Hard Drive

Features	Part Number
<ul style="list-style-type: none"><li>■ Required for collation</li><li>■ Extends font capacity</li></ul>	Z850HD

## DP Feature Set

Features	Part Number
<ul style="list-style-type: none"><li>■ High Resolution / Photo print-quality mode, 1200 x 600 dpi</li><li>■ Automatic two-sided printing capability</li><li>■ Adds 32 Mbytes of memory (64 Mbytes total)</li><li>■ 1st Page Preview functionality</li><li>■ Quick Collate functionality (requires a hard drive)</li><li>■ Page Pipelining</li></ul>	Z850FP

## PhaserShare® Network Card

Features	Part Number
<ul style="list-style-type: none"><li data-bbox="103 318 285 339">■ Easy to install</li><li data-bbox="103 355 370 376">■ Increases shareability</li><li data-bbox="103 393 573 415">■ High-performance network connectivity</li></ul>	Token Ring: ZNBTR



## The front panel

- Provides access to printer settings (tray, print-quality mode, network settings, etc.).
- Displays the printer's operating status (Ready to Print, Printing).
- Alerts you to replace consumables, load paper, and clear jams.

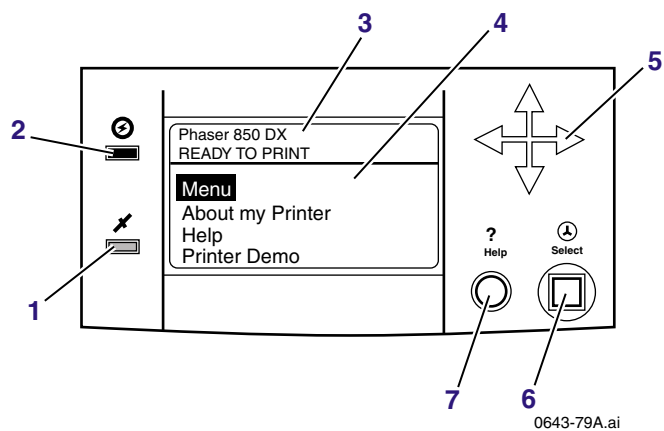

## Key

1. Error indicator
2. Power indicator
3. Printer model and current status
4. Display
  - **Menu:** Accesses printer setup menus
  - **About My Printer:** Displays current printer settings and information
  - **Help:** Accesses information and tools for solving printer problems
  - **Printer Demo:** Prints sample images and color charts
5. Navigation arrows. Use the arrows to scroll the front panel menus.
6. **Select** button. Selects highlighted settings.
7. **Help** button. Press at any time for additional information on displayed menu options or status messages.

Front Panel

## Printing a Menu Map

The **Menu Map** shows you where features such as the help pages, are located in the front panel's menu structure.

1. Scroll to **Menu**, press **Select**.
2. Scroll to **Print Menu Map**, press **Select**.

## Print quality modes

Features

Print quality modes selectable from a printer driver or the front panel	Maximum speed *
<b>Fast Color</b> <ul style="list-style-type: none"> <li>■ Fastest full-color output.</li> <li>■ Useful for many images and previewing work.</li> <li>■ Produces good peer-level documents.</li> <li>■ Useful for rush jobs when saturated colors are not necessary.</li> </ul>	14 ppm Paper 6.5 ppm Transparency
<b>Standard</b> <ul style="list-style-type: none"> <li>■ General-purpose mode for full-color printing.</li> <li>■ Best quality mode for printing transparencies.</li> <li>■ Suitable for most office uses.</li> <li>■ Produces vibrant, saturated prints with smooth color transitions.</li> </ul>	8 ppm Paper 3.5 ppm Transparency
<b>Enhanced **</b> <ul style="list-style-type: none"> <li>■ Superior text resolution and very smooth light colors.</li> <li>■ Balance of high quality and fast speed.</li> <li>■ Smoothest and brightest large-area fills.</li> <li>■ Useful for printing paper copies of overhead presentations.</li> </ul>	4 ppm Paper
<b>High Resolution/Photo **</b> <ul style="list-style-type: none"> <li>■ Highest-quality color prints.</li> <li>■ Near-photographic detail.</li> <li>■ 1200 x 600 dpi.</li> <li>■ Requires DP or DX Feature Set.</li> </ul>	2 ppm Paper

\*Approximate number of pages per minute; does not include image processing time. Based on prints with margins of .5 in. or greater.

\*\*Transparencies are printed in Standard mode.

## TekColor™ color corrections

<b>Color corrections selectable from a printer driver or the front panel</b>	<b>Description</b>
<b>Automatic</b>	<ul style="list-style-type: none"><li>■ Automatically applies the best color correction mode to each element on the page</li></ul>
<b>None</b>	<ul style="list-style-type: none"><li>■ No color correction made to colors</li><li>■ Used with the PANTONE® Color Chart for PANTONE® Color matching</li></ul>
<b>Vivid Color</b>	<ul style="list-style-type: none"><li>■ Produces the brightest possible colors and makes blues appear less purple</li></ul>
<b>sRGB Display</b>	<ul style="list-style-type: none"><li>■ Closely approximates the colors on a standard display screen</li></ul>
<b>SWOP Press</b>	<ul style="list-style-type: none"><li>■ Specification for Web Offset Publications. Used to match U. S. press standards</li></ul>
<b>Euroscale Press</b>	<ul style="list-style-type: none"><li>■ Used to match equivalent Imation Matchprint® proofs</li></ul>
<b>Commercial Press</b>	<ul style="list-style-type: none"><li>■ Used to match commercial Imation Matchprint® proofs</li></ul>
<b>SNAP Press</b>	<ul style="list-style-type: none"><li>■ Specifications for Non-Heat Advertising Printing</li><li>■ Used to match standards for printing on uncoated and newsprint papers</li></ul>
<b>DIC</b>	<ul style="list-style-type: none"><li>■ Used to match Dai Nippon printing inks on coated paper</li></ul>
<b>Toyo</b>	<ul style="list-style-type: none"><li>■ Used to match commercial Toyo printing inks on coated paper</li></ul>
<b>FujiProof</b>	<ul style="list-style-type: none"><li>■ Used to match the Fuji Color Art System for commercial North American proofs</li></ul>
<b>Black and White</b>	<ul style="list-style-type: none"><li>■ Grayscale printing</li><li>■ Used to print page masters for photocopying in black-and-white</li></ul>

## Paper tips

- Print the *Paper Tips Page* from the printer's front panel for a detailed list of paper types and sizes.
- When you select a tray by location (Upper, Middle, Lower) from a printer driver, the printer feeds from that tray.
- Always keep stored paper, transparencies, and labels, in sealed packages to avoid the effects of moisture which can affect feed reliability.
- Always use the manual-feed slot for heavy paper and envelopes.
- Handle transparencies by the edges and with both hands to avoid fingerprints and creases, which can result in poor print quality.
- Do not use three-hole punched paper, perforated paper, or an unsupported paper size.

## Supported page sizes and print area

The image area of a print is a bit smaller than the paper size. You may need to adjust the page margins in your application software to match the print area.

To print from a supported driver, select **Print**. Select **Page Size**. Choose one of the following sizes.

Paper*	Page size	Print area	Top/ Bottom margins	Left/ Right margins
1. Letter	8.5 x 11 in.	8.112 x 10.612 in.	.2 in.	.2 in.
2. Executive	7.25 x 10.5 in.	6.85 x 9.95 in.	.275 in.	.2 in.
3. A4	210 x 297 mm	200 x 287 mm	5 mm	5 mm
4. A5	148 x 210 mm	138 x 196 mm	7 mm	5 mm

\*Transparencies available in Letter- and A4-sizes only.

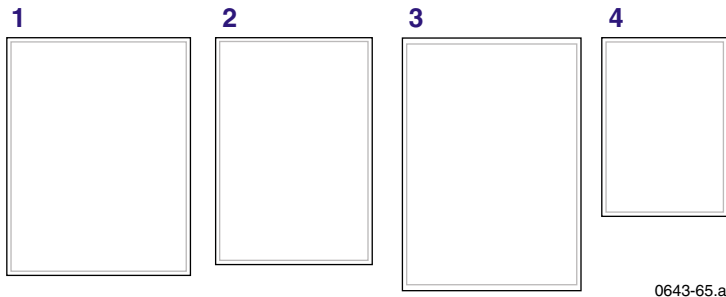

## Caution

Never use envelopes with windows or metal clasps; they will damage the printer. Use only the recommended envelope sizes. Envelopes must always be placed with the **flap face-up**.

For better results, use light-weight, laser-quality envelopes.

Envelopes	Page size	Print area	Top/ Bottom margins (A/B)	Left/ Right margins (C/D)
#10 (U. S.)	4.13 x 9.5 in.	3.73 x 8.95 in.	.2 in.	.275 in.
#6 $\frac{3}{4}$ (U. S.)	3.65 x 6.5 in.	3.25 x 5.95 in.	.2 in.	.275 in.
Monarch (U. S.)	3.875 x 7.5 in.	3.475 x 6.95 in.	.2 in.	.275 in.
C5	162 x 229 mm	152 x 197 mm	5 mm	7 mm 25 mm
DL	110 x 220 mm	100 x 206 mm	5 mm	7 mm
Choukei 3 Gou	120 x 235 mm	110 x 221 mm	5 mm	7 mm
Choukei 4 Gou	90 x 205 mm	80 x 191 mm	5 mm	7 mm

Paper Tips

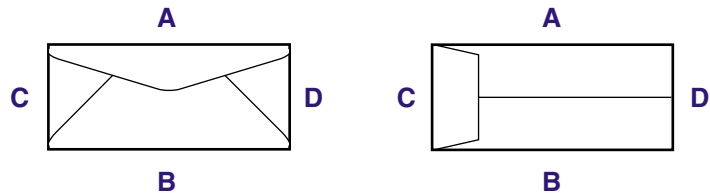

0643-155

# Manual-feed printing

## Supported media

See *page 1* for supplies ordering information.

### Paper

- Sizes:
  - A/Letter
  - Executive
  - A4
  - A5
- Bond or equivalent, 60 - 150 g/m<sup>2</sup>; 16 - 40 lb.
- Heavy papers 150 - 216 g/m<sup>2</sup>: for example, cover stock 216 g/m<sup>2</sup> or 80-lb., and index stock 110-lb.; single-sided printing only
- Coated or Glossy papers, single-sided printing only
- Short-grained paper, at least 105 g/m<sup>2</sup> and up to 150 g/m<sup>2</sup>; 28 - 40 lb. bond
- Tektronix Premium Cover, single-sided printing only
- Tektronix High Resolution Photo, single-sided printing only

### Transparencies

- Sizes: A/Letter and A4
- Use only Phaser 850 printer transparencies

### Labels

- Sizes: A/Letter and A4
- Use only Phaser 850 printer Color Printing Labels



## Envelopes

For better results, use light-weight, laser-quality envelopes.

- #10 (U. S.)
- #6 3/4 (U. S.)
- Monarch (U. S.)
- C5
- DL
- Choukei 3 Gou
- Choukei 4 Gou

## Using the manual-feed slot for single-sided printing

To use the manual-feed slot for single-sided printing, follow these steps. To use the manual-feed slot for two-sided printing, see *Automatic two-sided printing* on page 32.

### Note

Refer to *page 34* for instructions on loading letterhead for two-sided printing.

1. In a supported printer driver, select **Manual Feed Paper** or **Manual Feed Transparency**.
  - Make sure that two-sided printing is turned off in the printer driver.
2. To send the job to the printer, click **Print**.

3. Open the manual-feed slot.
4. Align the paper, transparency, or envelope, with the left side of the slot. For either Letter- or A4-size, adjust the guides on the right side of the slot.

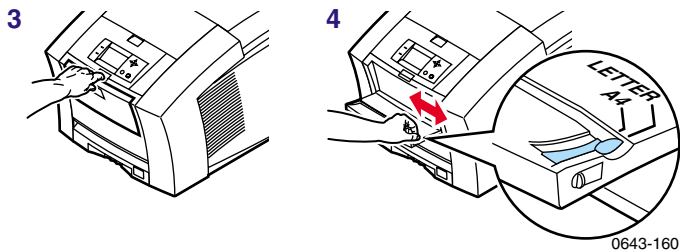

5. When the front panel reads **Waiting for Manual Feed**, insert one sheet or envelope until the printer pulls it in:
  - Top of the page enters **first**.
  - Side to be printed is **face-down**.
  - To avoid jams, make sure the sheet or envelope is properly aligned as it enters the printer
  - Check the first print to make sure the image placement is correct.
6. Wait for the front panel's prompt before inserting additional sheets.

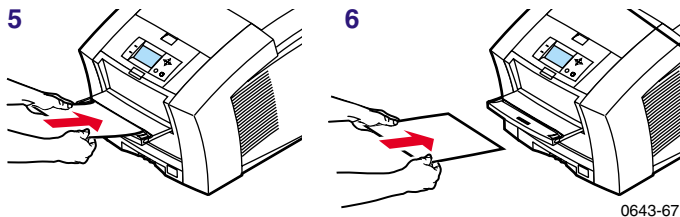

## Manual-feed speciality media overview

### 1. Letterhead or High-Resolution Photo

See *Loading letterhead paper for two-sided printing* on page 34 and *Printing on High Resolution Photo Paper* on page 29 for more information.

### 2. Transparencies

### 3. Labels

See *Printing on labels* on page 30 for more information.

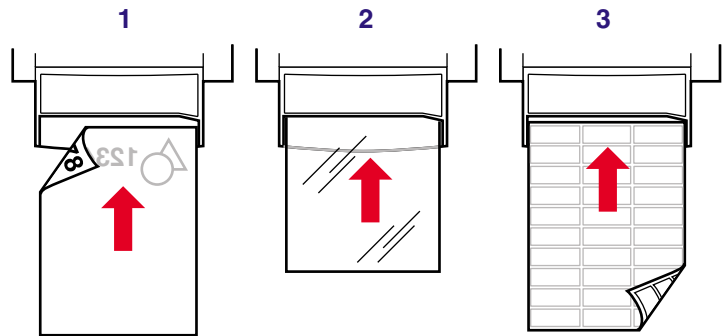

0643-68

## 1. Envelopes

See *Printing on envelopes* on page 18 for more information.

## 2. Executive/A5 small papers

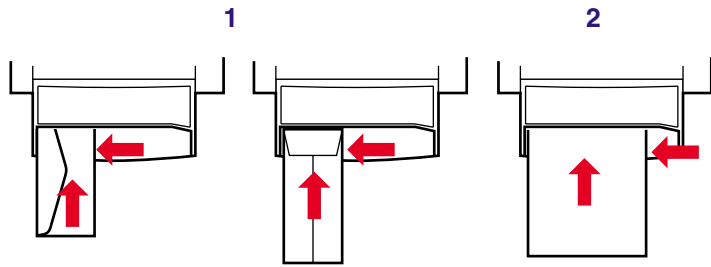

0643-149

### Caution

Never use envelopes with windows or metal clasps; they will damage the printer. Only use the recommended envelope sizes. Envelopes must always be placed with the **flap face-up**.

## Printing on envelopes

1. In your application, create a document matching the measurements of the envelope (see *page 11* for dimensions).
2. From your application, make these selections and send the job to the printer:
  - Set the orientation to **Landscape**.
  - Select your envelope size.
  - Select **Manual Feed Paper** as the **Paper Source**.
  - If your application has a tool for creating envelopes, select the feed method that matches the illustration in Step 4.
3. Wait for the front panel prompt before loading an envelope.
4. Insert one envelope into the manual-feed slot:
  - Short end enters **first**.
  - Side with the **flap** is **face-up**.
  - Flap is closed.
  - For side-flap envelopes: **Flap end** is on the **left**.  
For end-flap envelopes: **Flap end** enters **first**.

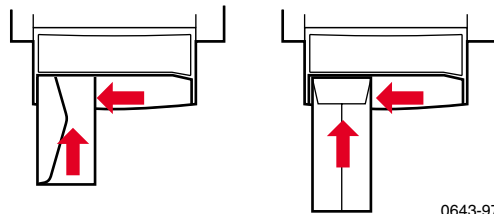

## Guidelines for envelope printing

- Use the recommended envelope sizes (see *page 11*)
- For better results, use light-weight, laser-quality envelopes.
- No windows or metal clasps
- No exposed gummed surfaces
- Single-sided printing only
- Keep unused envelopes in their original packaging to avoid dust
- Many applications include a tool for creating an envelope. Refer to your application's documentation.

## Printing envelopes from a Macintosh

To print envelopes from Microsoft WORD on a Macintosh, follow these steps:

1. From the **Tools** menu, select **Envelopes and Labels**.
2. In the **Envelopes and Labels** dialog box, click the **Envelopes** tab.
3. In the **Envelopes** tab, type in delivery and return addresses.
4. Click the **Feed** icon.
5. In the **Printing Options** tab, select all of the following:
  - **Face Down**
  - **Clockwise Rotation**
  - **Use Envelope Feeder**
  - Left envelope feed icon:

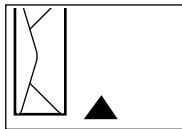

0643-148.ai

6. Click the **Envelope Options** tab.
7. In the **Envelope size** drop-down list, select your envelope size.
8. Click **OK**.
9. In the **Envelopes and Labels** dialog box, click **Print** to open the **Page Setup** dialog box.
10. In the **Page Setup** dialog box, select all of the following **Page Attributes**:
  - **Paper:** select your envelope size.
  - **Orientation:** select **Landscape**.
11. From the drop-down list, select **PostScript Options**, and make the following selections:
  - **Flip Horizontal**
  - **Flip Vertical**
12. Click **OK**; the **Print** dialog box opens.
13. In the **Print** dialog box, in **General** options, for **Paper Source** select **Manual Feed Paper**.
14. Click **Print**.
15. The printer's front panel prompts you to insert the envelope.

**From other Macintosh applications:** If the envelope address prints upside-down, change the **Page Setup** settings in your printer driver before printing:

1. From the **File** menu, select **Page Setup**.
2. Select the following **Page Attributes**:
  - **Paper:** select your envelope size.
  - **Orientation:** select **Landscape**.
3. From the drop-down list, select **PostScript Options**, and make the following selections:
  - **Flip Horizontal**
  - **Flip Vertical**
4. Click **OK**.
5. From the **File** menu, select **Print**.
6. For **Paper Source**, select **Manual Feed Paper**.
7. To print, click **Print**.



## Printing envelopes from Windows

To print envelopes from Microsoft WORD for Windows, follow these steps:

1. From the **Tools** menu, select **Envelopes and Labels**.
2. In the **Envelopes and Labels** dialog box, click the **Envelopes** tab.
3. In the **Envelopes** tab, type in delivery and return addresses.
4. Click the **Feed** icon.
5. In the **Printing Options** tab, select all of the following:
  - **Face Down**
  - **Clockwise Rotation**
  - For **Feed From**, select **Manual Feed Paper**.
  - Left envelope feed icon:

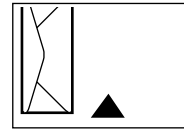

0643-148.ai

6. Click the **Envelope Options** tab.
7. In the **Envelope size** drop-down list, select your envelope size.
8. Click **OK**.
9. In the **Envelopes and Labels** dialog box, click **Print**.
10. The printer's front panel prompts you to insert the envelope.

# Loading the Standard Paper/ Transparency Tray

## Supported media

See *page 1* for supplies ordering information.

### Paper

- 200-sheet capacity
- Bond or equivalent, 60 - 150 g/m<sup>2</sup>, 16 - 40 lb.
- Heavy papers 150 - 176 g/m<sup>2</sup>, 40 - 65-lb.; for example, cover stock 176 g/m<sup>2</sup> or 65-lb.; single-sided printing only
- Coated or glossy papers, single-sided printing only
- Short-grained paper, 105 - 150 g/m<sup>2</sup>, 28 - 40 lb. bond
- Tektronix Premium Cover, single-sided printing only
- Tektronix High Resolution Photo, single-sided printing only
- Set tray switch to **Paper**.

### Transparencies

- 50-sheet capacity
- Use only Phaser 850 printer transparencies
- Set tray switch to **Transparency**.

### Labels

- 50-sheet capacity
- Use only Phaser 850 printer Color Printing Labels
- Set tray switch to **Paper**.

## Loading the tray

1. Use the tray's maximum-capacity label to determine how much paper or transparency to load.
2. Load paper with the side to be printed **face-up**.
  - For single-sided printing, load letterhead paper with the top of the page at the front of the tray.
  - For two-sided printing on letterhead, refer to *page 34*.
3. Place the paper snugly against the inside left front wall of the tray.
4. Set the switch on the side of the tray for **Paper** or **Transparency** to match the loaded media. If you are loading labels in the Paper/Transparency tray, set the tray switch to **Paper**.
5. Insert the tray into the printer.

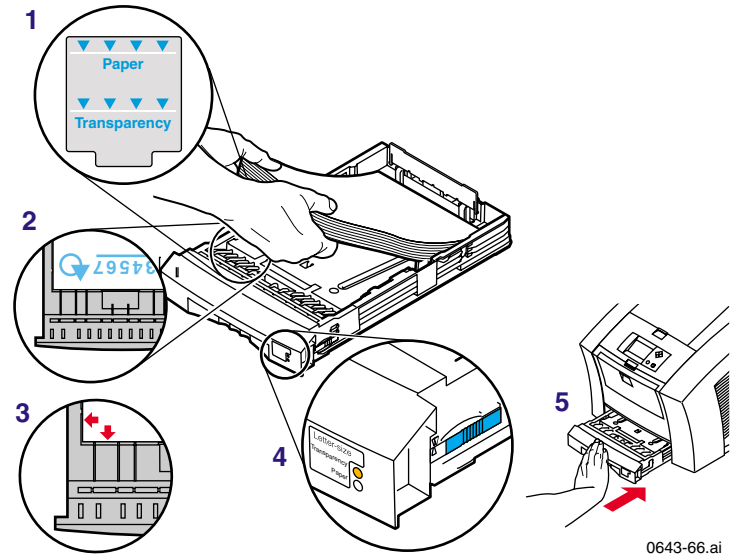

# Loading the High-Capacity Paper Tray Assembly

## Supported media

See *page 1* for supplies ordering information.

### Paper only

- 500-sheet capacity
- Bond or equivalent, 63 - 120 g/m<sup>2</sup>, 17 - 32 lb.
- You can use up to two High-Capacity Paper Tray Assemblies with your printer.

## Loading the tray

1. Angle the paper stack to match the angle of the tray.
2. Use the tray's maximum-capacity label to determine how much paper to load.
3. Load paper with the side to be printed **face-up**.
  - For single-sided printing, load letterhead paper with the top of the page at the front of the tray.
  - For two-sided printing on letterhead, refer to *page 34*.
4. Place the paper snugly against the inside left back wall of the tray.

5. Insert the tray into the printer.

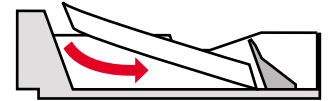
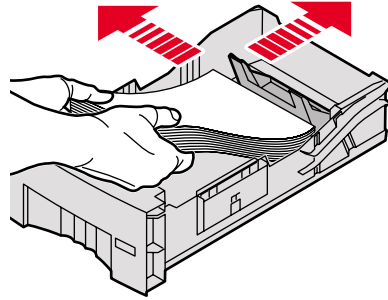

0389-19

# Loading the optional High-Capacity Transparency/Label Tray

## Supported media

See *page 1* for supplies ordering information.

### Transparencies

- 175-sheet capacity
- Use only Phaser 850 printer transparencies
- Set tray switch to **Transparency**.

### Labels

- 100-sheet capacity
- Use only Phaser 850 printer Color Printing Labels
- Set tray switch to **Label**.

## Loading the tray

1. Use the tray's maximum-capacity label to determine how much media to load.
2. Load media with the side to be printed **face-up**.
3. Place the media snugly against the inside left back wall of the tray.
4. Set the switch on the side of the tray for **Transparency** or **Label** to match the loaded media.
5. Insert the tray into the printer.

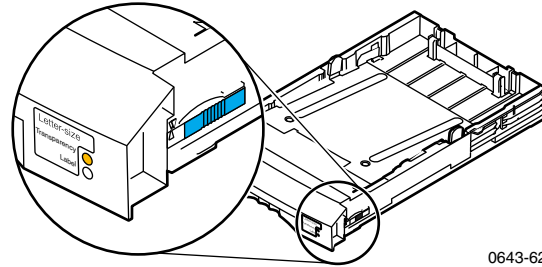

0643-62

6. In the printer driver, make these selections:
  - Select the appropriate tray.
  - Turn off the two-sided printing option.

# Printing on High Resolution Photo Paper

The Tektronix High Resolution Photo Paper is printable on one side only, and has a Tektronix logo on the reverse.

See *page 1* for supplies ordering information.

1. Insert the paper into the appropriate tray:
  - Standard Paper/Transparency tray: 50 sheets**
    - Load paper face-up
    - Set tray switch to **Paper**.
  - Manual-feed slot: 1 sheet**
    - Load paper face-down
2. In the printer driver, make these selections:
  - Select the appropriate tray.
  - Turn off the two-sided printing option.
  - Select **High-Resolution Photo** as the TekColor color correction.
3. Send the job to the printer.



## Printing on labels

1. Insert the label sheets into the appropriate tray:

### Standard Paper/Transparency tray: 50 sheets

- Face-up
- Set tray switch to **Paper**.

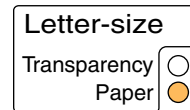
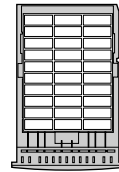

0643-159

### High-Capacity Transparency/Label tray: 100 sheets

- Face-up
- Set tray switch to **Label**.

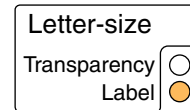
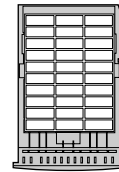

0643-99.ai

### Manual-feed slot: 1 sheet

- Face-down

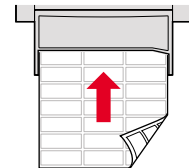

0643-96.ai

2. If your application has a setting for labels, use it as a template. Otherwise, for margin settings, refer to the instructions included with the labels.
3. In the printer driver, make these selections:
  - Select the appropriate tray.
  - Turn off the two-sided printing option.
4. Send the job to the printer.

See *page 1* for supplies ordering information.

## Guidelines for printing on labels

- Use only Phaser 850 printer Color Printing Labels.
- If any of the labels on a sheet are missing, do not use that sheet; it may damage printer components.

### Caution

Keep labels in a cool, dry place. Never store labels in a high-humidity environment. Labels stored under such conditions will jam in the printer. Store unused labels flat in their containers. Rotate stock frequently. Long periods of storage can cause the labels to curl and will jam the printer.

## Automatic two-sided printing

Automatically make two-sided prints using the paper trays or the manual-feed slot. In the Print dialog box, select the two-sided printing option and a binding preference (how the page turns).

### To automatically make two-sided prints:

- Do not place paper that was printed on one side back into the printer to print on the second side. Pre-printed pages may stick together.
- Make sure the Paper/Transparency switch on the tray is set to **Paper**.
- Use only Letter- or A4-size paper.
- When the printer operates in automatic two-sided printing mode, the paper partially exits before printing the second side. To avoid paper jams, do not touch the paper before it completely exits the printer.

### Caution

Two-sided printing is supported only for Letter- and A4-size papers within the 16 - 32 lb. range. Make sure two-sided printing is off in the printer driver for all other paper types.

### Macintosh Drivers

---

#### LaserWriter 8.6

- From the **File** menu, select **Print**.
- From the pull-down menu, select **Layout**.
- Select **Print on Both Sides**.
- Select a binding preference.

---

#### LaserWriter 8.3.4

- From the **File** menu, select **Print**.
  - Click the **Options** button.
  - Select **2-Sided Printing**.
  - Select **Short-Edge Binding** or **Long-Edge Binding**.
-

## PC Drivers

- 
- |                    |  |
|--------------------|--|
| <b>Windows 95</b>  | <ul style="list-style-type: none"><li>■ From the <b>File</b> menu, select <b>Print</b>.</li></ul>  |
| <b>Windows 98</b>  | <ul style="list-style-type: none"><li>■ Click <b>Properties</b>.</li><li>■ Click the <b>Setup</b> tab.</li><li>■ Select <b>Print on 2 sides</b>.</li><li>■ Check or uncheck <b>Bind on top edge</b>.</li></ul>   |
| <b>Windows NT4</b> | <ul style="list-style-type: none"><li>■ <b>Start/Settings/Printers</b>.</li><li>■ Right-mouse-button-click on your printer's icon.</li><li>■ From the pop-up menu, select <b>Document Defaults</b>.</li><li>■ Click the <b>Advanced</b> tab.</li><li>■ Under <b>Paper/Output</b>, select <b>Print on Both Sides</b>.</li><li>■ Select <b>Long Side</b> or <b>Short Side</b>.</li></ul> |
- 

## Binding preference

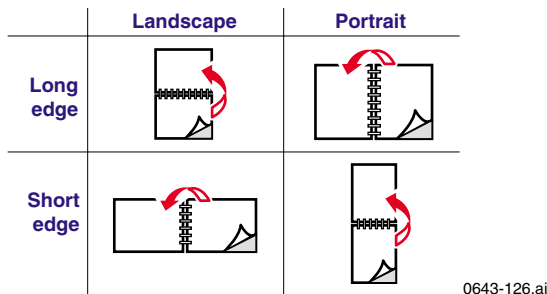

## Loading letterhead paper for two-sided printing

To load letterhead paper for two-sided printing, follow these *additional* steps.

### Caution

Do not place paper that was printed on one side back into the printer to print on the second side. Pre-printed pages may stick together.

1. Load the paper in the paper tray or the manual-feed slot:

- **Paper tray**

Letterhead side is **face-down**.

Place the **top** of the page at the back of the tray.

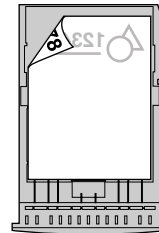

0643-98

- **Manual-feed slot**

Letterhead side is **face-up**.

Top of the page enters the printer last.

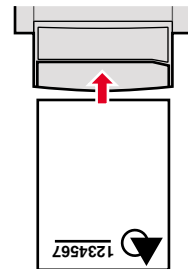

0643-69

2. In your printer driver, in the **Print** dialog box, select the tray by location:
  - **Upper**
  - **Middle**
  - **Lower**
  - **Manual Feed Paper**

**Note**

When the printer operates in automatic two-sided printing mode, the paper partially exits before printing the second side. To avoid paper jams, do not touch the paper before it completely exits the printer.

# Adding ink

## Caution

Use only Phaser 850 printer ColorStix® ink; the use of other ink may affect print quality and reliability. Tektronix warranties and service contracts do not cover damage, malfunction or degradation of performance caused by the use of non-Tektronix supplies or consumables or the use of Tektronix supplies not specified for use with this printer.

See *page 1* for supplies ordering information.

## Ink tips:

- Keep ink in its packaging until you are ready to use it.
- To avoid ink jams, never insert broken ink sticks into the ink-loading bins.

## Loading ink:

To load ink any time the printer is Idle, or when the front panel displays **Ink low** or **Ink out**, follow this procedure.

1. Open the top cover. A color-coded label inside the top cover corresponds to the color of each ink-loading bin.
2. Remove the ink stick from its packaging.

3. Place the appropriate color ink stick into the ink-loading bin that appears low. Do not force the ink sticks into the ink-loading bins.

Each ink stick is uniquely shaped to fit into the correct ink-loading bin. Insert the ink stick's narrow end first.

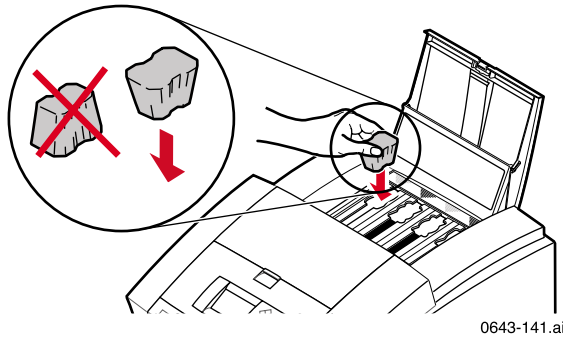

Adding Ink

4. Close the top cover.

The front panel may read **Processing** until the printer is ready for printing.



## Emptying the waste tray

When the front panel displays **Empty Waste Tray**, follow this procedure.

See *page 1* for supplies ordering information.

### Caution

The printer's interior may be hot. Do not reach into the printer while the maintenance drawer is removed.

1. Open the front cover.
2. Grasp the maintenance drawer, labeled as **A**, and pull it out of the printer.

### Note

The maintenance drawer may be locked while the ink cools after the front panel troubleshooting routine, **Eliminate Light Stripes**. Make sure all covers are closed. Wait 15 minutes before trying to remove the maintenance drawer. The maintenance drawer may also be locked during the warm up cycle whenever the printer is turned on.

- 3. The waste tray may be hot; handle it carefully.**  
Lift the waste tray, labeled as **B**, from the maintenance drawer.

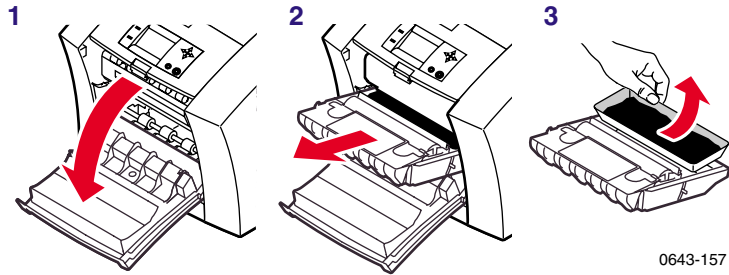

- 4.** Empty the waste tray by gently twisting the tray or tapping it on the sides of a waste container. Ink is non-toxic and can be discarded as normal office waste.
- 5.** Replace the waste tray in the maintenance drawer. Make sure the waste tray is seated flat in the maintenance drawer.
- 6.** Reinsert the maintenance drawer into the printer and close the front cover.

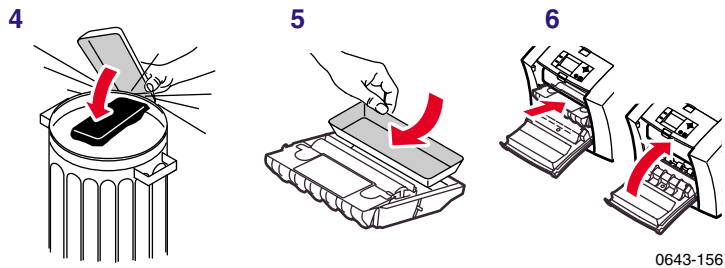

## Replacing the Maintenance Kit

The Maintenance Kit is a consumable that consists of the maintenance roller and counter. The kit is located in the Maintenance Drawer, labeled as **A**, behind the printer's front cover.

Detailed, illustrated instructions are included with each new Maintenance Kit. See *page 1* for supplies ordering information.

The front panel displays these messages:

<b>Front panel message</b>	<b>Action</b>
Maintenance Kit is low	Order a replacement maintenance kit; replace the Maintenance Kit soon.
Replace Maintenance Kit	Replace the Maintenance Kit to continue printing. Make sure the new counter is installed.
Maintenance Kit Missing	Reinstall the counter or maintenance drawer.
Preventative Maintenance: Replace Maintenance Kit	Press the Help button on the front panel for details.

- The Standard Maintenance Kit has a life of 10,000 prints or 2 years, whichever comes first.
- The Extended Maintenance Kit has a life of up to 45,000 prints (depending on ink coverage) or 2 years, whichever comes first.

## Caution

The printer may be hot. Do not reach into the printer while the maintenance drawer is removed.

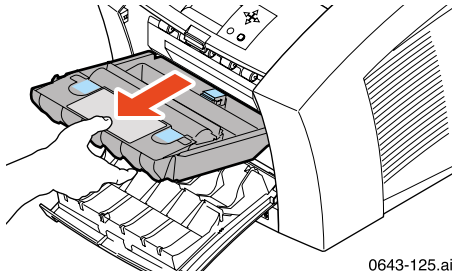

## Removing paper jams

The front panel message indicates the jam location and information on how to clear the jam. Check the front panel for **Troubleshooting Jams** information.

To prevent jams, use **only** the recommended papers, transparencies, and labels (see *page 10*), and clean the printer's rollers if visibly dirty. For complete cleaning instructions, refer to the printer's CD-ROM or on the Tektronix web site.

### Media Jam – Open Exit Cover to Clear

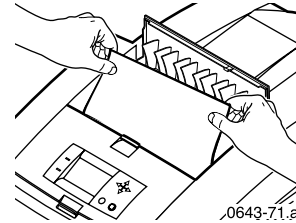

Jams

#### Solution 1

If the paper has partially exited the printer at the exit slot, follow these steps. Otherwise, refer to *Solution 2* on page 43.

1. Open the exit cover.
2. Using both hands, remove the jammed paper.
3. Remove the entire sheet of paper; any pieces of paper left in the printer may cause more jams.

## Solution 2

If paper gets caught under the Rapid Release Guide, follow these steps.

### Caution

Handle the Rapid Release Guide carefully to avoid bending or damaging the clear plastic edge.

1. Open the exit cover.
2. Lift the blue paper guide.

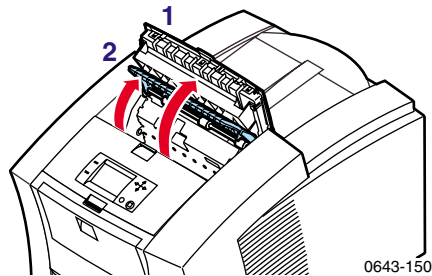

3. Lift up on the blue tabs and remove the Rapid Release Guide. Do not use any sharp objects in this area of the printer.

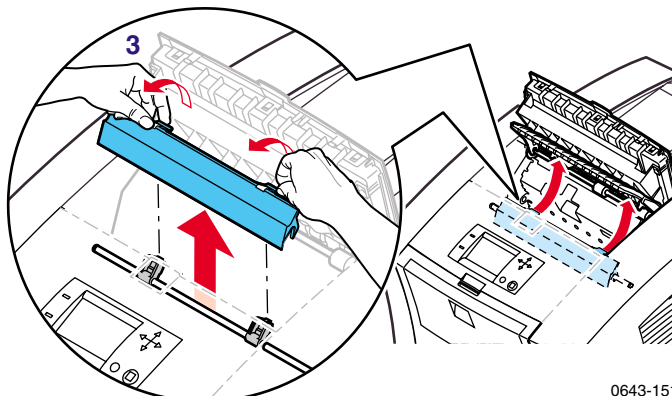

4. Remove the jammed paper.

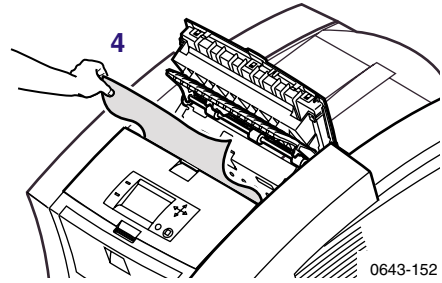

5. Make sure the thin, white dust shield is lying on top of the metal shaft. Then, reinstall the Rapid Release Guide, pressing down on the blue tabs to snap the guide into place.

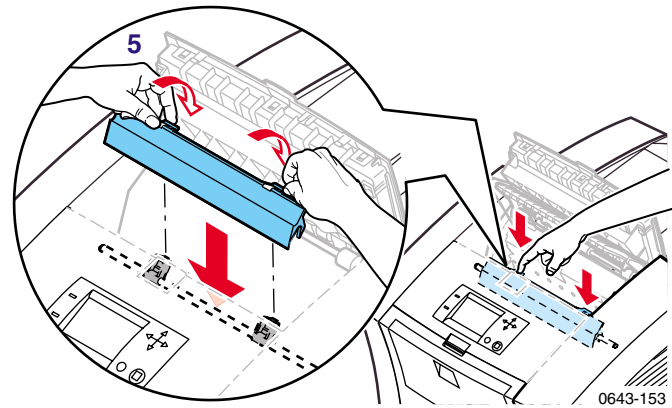

## Media Jam – Open front cover to clear

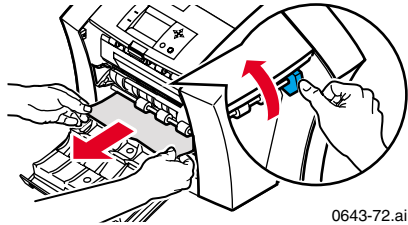

1. Open the front cover.
2. Using both hands, remove the jammed paper.
3. If there is any resistance to removing the jammed paper, turn the blue thumbwheel to help feed the paper.
4. Remove the entire sheet of paper; any pieces of paper left in the printer may cause more jams.



## Media Jam – Retry manual feed

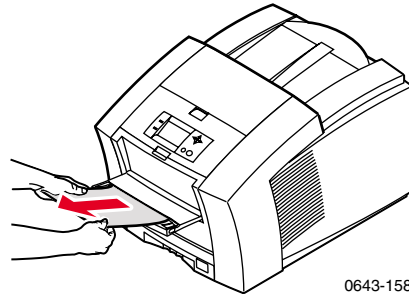

0643-158

1. Using both hands, remove the jammed paper, transparency, or label sheet.
2. When prompted by the display message, reinsert the sheet using both hands.

Make sure you insert the sheet properly, so it enters the printer straight and evenly. Be especially careful to properly line up envelopes and small-size papers.

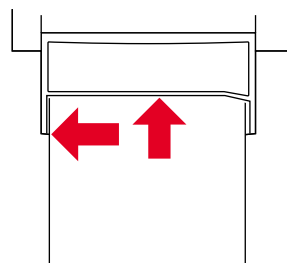

0643-143.ai

## Media Jam – Remove media (or upper) tray to clear

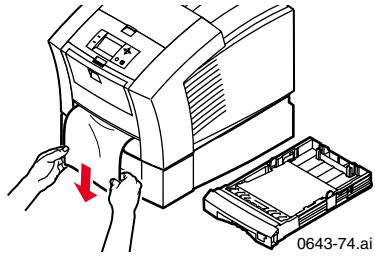

1. Remove the paper tray (if your printer has more than one tray, pull out the upper tray).
2. Using both hands, remove the jammed paper.

Media Jam – Remove middle tray to clear

Media Jam – Remove lower tray to clear

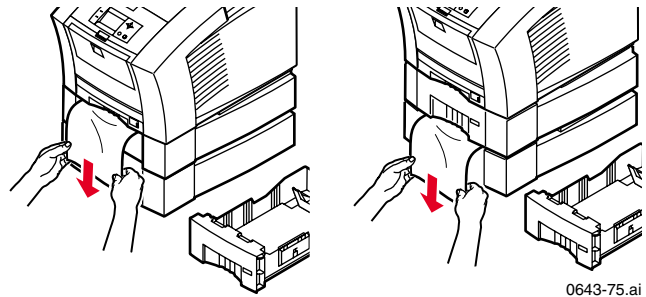

1. Remove the paper tray named in the front panel display.
2. Using both hands, carefully remove the jammed paper.

# Troubleshooting print quality

## Light stripes or missing colors

Clean the printhead with the printer's front panel troubleshooting routine.

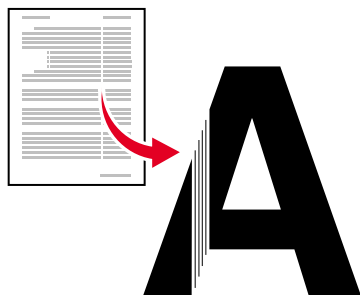

0643-56.ai

Print Quality

1. On the front panel, scroll to **Menu**. Press **Select**.
2. Scroll to **Troubleshooting**; press **Select**.
3. Scroll to **Print Diagnostic Test Page**; press **Select**. These illustrations show a correct Test Page and an example of a Test Page with a missing color bar.

### A. Correct test page

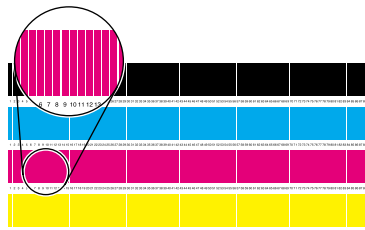

### B. Missing color bar

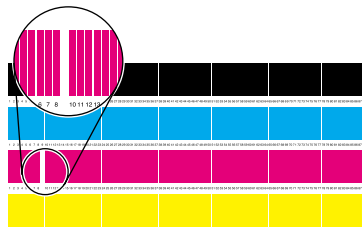

0643-135.ai

4. If the test print looks like example **B** in the illustration, go on to Step 5.
5. Scroll to **Eliminate Light Stripes**; press **Select**.
6. Check the test print that prints automatically, to confirm that the problem is corrected.
7. Repeat Step 5 as necessary. If light stripes persist after three consecutive clean cycles, turn off the printer for 4 hours to allow the ink to cool and solidify. Then turn on the printer and repeat the clean cycles, if necessary.

For more details, refer to the troubleshooting information on the printer's CD-ROM or on the Tektronix web site.

## Oil or ink smears

Oil (drum fluid) on a print or ink smears on the front, back or edges of a page.

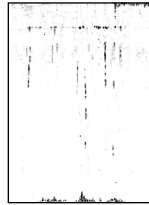

0643-59.ai

Clean the printer's internal paper path using the front panel troubleshooting routine.

1. Load the upper tray with sheets of clean, high-grade paper, preferably 120 g/m<sup>2</sup>; 32-lb. This cleaning routine uses several sheets of paper.
2. On the front panel, scroll to **Menu**. Press **Select**.
3. Scroll to **Troubleshooting**; press **Select**.
4. Scroll to **Remove Ink Smears**; press **Select**.
5. If the problem persists, additional cleaning may be necessary. For complete cleaning instructions, refer to the printer's CD-ROM or on the Tektronix web site.

## Ink streaks

Ink streaks or marks on the top edge, front or back of a page.

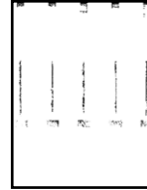

0643-60.ai

### Clean the printer's paper-exit path:

- To clean the exit rollers, use a pre-soaked alcohol cloth.
- To turn the rollers, use the blue thumbwheel.

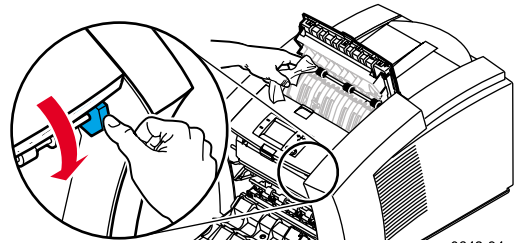

0643-94.ai

### Clean the Rapid Release Guide:

1. Follow the steps in *Solution 2* on page 43 to remove the Rapid Release Guide.
2. Gently wipe the clear plastic Rapid Release Guide with a pre-soaked alcohol cloth.

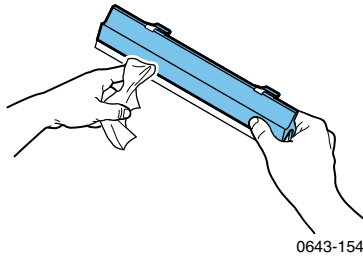

3. Reinstall the Rapid Release Guide, pressing down on the blue tabs to snap the guide into place.



## Ink smears

Ink smears on the bottom edge of a page.

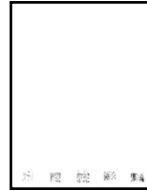

0643-57.ai

Clean the paper-feed rollers.

1. From the front panel, run the **Remove Ink Smears** routine; see *page 51* for instructions.
2. If smears remain, open the front cover and remove the maintenance drawer.
3. To clean rollers in rows **1, 2,** and **3,** use a pre-soaked alcohol cloth.
4. To turn the rollers in rows **1** and **3,** use the blue thumbwheel.

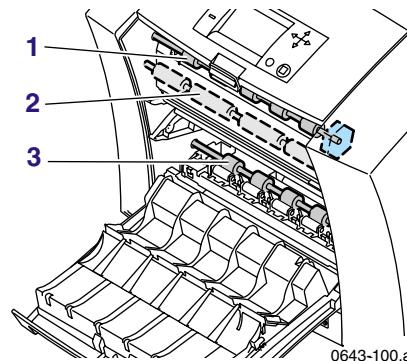

0643-100.ai

5. Clean any ink from the polished metal guide located between rollers 1 and 2, using a presoaked alcohol wipe.

# Moving the printer

## All moves

Follow these guidelines when moving the printer within the office and preparing it for shipment:

1. The printer must be cool before moving it; otherwise, ink spills may damage the printer. Use this method:
  - a. Close all of the printer's covers and doors.
  - b. Turn off the printer. Before the front panel goes blank (*you have only 4 seconds*), select **Shut Down For Moving Printer**.
  - c. The printer takes about 15 minutes to cool; during that time, the front panel reports its progress. When the cool-down is complete, the front panel goes blank. It is now safe to move the printer.
2. Removing the upper paper tray provides a place for your hands when lifting the printer.
3. Always move the printer separately from its High-Capacity Paper Tray Assembly.

Moving

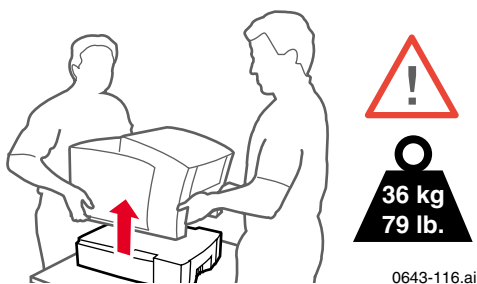

## Preparing the printer for shipment

### Caution

Parts of the printer may be hot; to avoid personal injury, allow the printer to cool and use caution when handling it.

- Always repack the printer properly to ensure its safe shipment; refer to the instructions on the printer's CD-ROM or on the Tektronix web site.
- Always remove the maintenance drawer (A) before shipment to avoid damage to the printer. Place the drawer in a plastic bag for storage. Never ship the printer with the maintenance drawer installed.

Moving

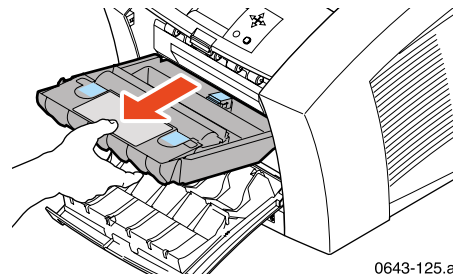

0643-125.ai

# Getting help

The printer's auto-running CD-ROM guides you to the various resources available for installing and learning more about your Tektronix color printer. Use the CD-ROM to install your printer driver software, view and print user documentation, and watch "how to" videos. Live Internet links on the CD-ROM let you access the Tektronix Color Connection web site, your single source for color education, interactive tutorials, free templates and support information.

## Printer CD-ROM

- Advanced Features and Troubleshooting Manual
- Consumables instructions
- Setup Guide poster
- Video help
- Networking manuals
- Cleaning instructions
- Repacking instructions
- Printer drivers
- Material Safety Data Sheets (MSDS)

## Windows driver help system

Install the driver from the printer's CD-ROM and use the embedded help system.

- Troubleshooting information
- Access to installed manuals and videos
- Live links to the Tektronix web site

## Color Connection

**colorconnection.tektronix.com**

Color resource for tools and information to help you get the most out of your color printer:

- Customized support and automatic driver update notification.
- Color education with interactive tutorials and helpful hints.
- Free templates and promotions.
- Online supplies ordering
- Online documentation.

## Printer's front panel

- **Help** menu: Accesses information and tools for solving printer problems.
- **Help** button: Press at any time for additional information on displayed menu options or status messages.
- **Troubleshoot Jams** menu: Appears when paper jams, provides additional information.

## Internal printer pages

The printer has several help pages available; refer to the Menu Map for their locations.

- **Connection Setup:** connecting to a computer or network
- **Diagnostic Test Page:** how to solve print problems, such as smudges or light stripes
- **Help Guide:** Provides specific help resources.
- **Paper Tips Page:** what papers, transparencies, or labels to use
- **Supplies Page:** part numbers and descriptions

## PhaserLink™ Software

**[www.tek.com/Color\\_Printers/products/phaserlink.html](http://www.tek.com/Color_Printers/products/phaserlink.html)**

- View printer status using any web browser
- Control printer settings
- Link to online documentation via the World Wide Web
- Receive electronic mail when consumables are low or other printer maintenance is required
- Requires network connection via TCP/IP

## Tektronix web site

**[www.tek.com/Color\\_Printers/](http://www.tek.com/Color_Printers/)**

- Product and supplies information
- Finding your local reseller

## TekSMART™ Knowledge Base

**[www2.tek.com/TekSMART/](http://www2.tek.com/TekSMART/)**

- Application issues
- Networking issues
- Printer errors
- Print quality issues
- Troubleshooting
- Latest tips from technical support

## Other online services

---

<b>Anonymous ftp server</b>	<a href="ftp.tek.com/Color_Printers/">ftp.tek.com/Color_Printers/</a>
<b>Subscribe to email update notices</b>	<a href="http://www.tektronix.com/Color_Printers/support/subscribe.html">www.tektronix.com/Color_Printers/support/subscribe.html</a>

---

## Customer Support Centers

<b>Australia</b> 1-800-811-177	<b>France</b> 01 69 86 8137	<b>New Zealand</b> +61 2 9888 0100
<b>Austria</b> 0660 5804	<b>Germany</b> 0180 525 3535	<b>Norway</b> 22 723 801
<b>Belgium</b> 02 720 9602	<b>Hong Kong</b> 2585-6655	<b>Singapore (ASEAN)</b> 1-800-356-5565
<b>Brazil</b> 0800 16 0220	<b>India (South Asia)</b> (91) 80-227-5577	<b>Spain</b> 902 239 272
<b>Canada</b> 1-800-835-6100	<b>Italy</b> 02 45 287 000	<b>Sweden</b> (08) 299 071
<b>China</b> 10-6235-1230	<b>Japan</b> 81 3 3448 4872	<b>Switzerland</b> 01 212 2212
<b>Denmark</b> (44) 533 444	<b>Korea</b> 2-528-4661	<b>Taiwan</b> (02) 2757-1571
<b>Eastern Europe and the Middle East</b> +44 1908 68187	<b>Luxembourg</b> 400 847	<b>Thailand</b> 2-645-4407
<b>Finland</b> 0203 206 30	<b>Netherlands</b> (040) 267 0440	<b>U. K.</b> (01) 908 681 707
		<b>U. S.</b> 1-800-835-6100

# Index

## A

- accessories
  - ordering information 1
- adding ink sticks 36
- Automatic color correction 9

## B

- Black and White color correction 9

## C

- cart for printer, ordering information 4
- cleaning
  - for print quality 49
- cleaning kit
  - ordering information 3
- clearing paper jams (brief) 42
- color corrections
  - Automatic 9
  - Black and White 9
  - Commercial Press 9
  - DIC 9
  - Euroscale Press 9
  - FujiProof 9
  - None 9
  - SNAP Press 9
  - sRGB Display 9
  - SWOP Press 9
  - Toyo 9
  - Vivid Color 9
- ColorStix ink
  - loading 36
  - ordering information 1
- Commercial Press color correction 9
- consumables
  - adding ink sticks 36
  - Maintenance Kit 40



## D

- DIC color correction 9
- DP Feature Set, ordering information 4

## E

- Eliminate Light Stripes
  - brief procedure 49
- Enhanced print quality mode 8
- envelopes
  - guidelines 19
  - printing details 18
  - printing from Microsoft Word, Macintosh 19
  - printing from Microsoft Word, Windows 22
  - printing from the manual-feed slot 14
  - sizes 12
- Euroscale Press color correction 9

## F

- Fast Color print quality mode 8
- Feature Set, DP, ordering information 4
- front panel
  - About My Printer 7
  - buttons 7
  - Help 7
  - introduction 6
  - Menu 7
  - Printer Demo 7
- FujiProof color correction 9

## H

- hard disk, ordering information 4
- High Resolution Photo
  - paper, ordering information 1
  - paper, printing on 29
  - print quality mode 8
- High-Capacity Paper Tray Assembly
  - ordering information 4

## I

- IDE hard drive, ordering information 4
- information resources 57
- ink sticks
  - loading 36
  - ordering information 1

## J

- jams, paper
  - brief procedure 42

## L

- labels
  - guidelines 31
  - ordering information 2
  - printing on 30
  - storing 31
- light stripesbrief procedure 49

## M

- Maintenance Kit
  - ordering information 2
  - replacing 40
- manual feed
  - 2-sided printing 32
  - single-sided printing 14
  - supported media 13
- margins
  - envelopes 12
  - paper 11
- media
  - ordering information 1
  - tips 10
- media jams
  - exit cover 42
  - front cover 45
  - manual feed 46
  - trays 47

- memory, printer, ordering information 3
- modes
  - print quality 8
- moving the printer 55

## N

- None color correction 9

## O

- online color resource 57

## P

- paper

- jams (brief) 42
- margins 11
- ordering information 1
- print area 11
- sizes 11
- tips 10

- paper jams

- exit cover 42
- front cover 45
- manual feed 46
- trays 47

- paper trays

- ordering information 3

- PhaserShare Token Ring network card, ordering information 5

- print area

- envelopes 12
- paper 11

- print quality modes 8

- Enhanced 8
- Fast Color 8
- High Resolution/Photo 8
- Standard 8

- print speed 8

## printer

- cart, ordering information 4
- color corrections 9
- feature set, ordering information 4
- front panel 6
- memory, ordering information 3
- moving 55
- print speed 8
- quality modes 8
- shipping 56
- station, ordering information 4

## R

### Rapid Release Guide

- cleaning (brief procedure) 53
  - ordering a replacement 3
  - paper jam 43
- replaceable parts
- ordering information 3

## S

- shipping the printer 56
- smears
- ink 54
  - oil or ink 51
- SNAP Press color correction 9
  - speed of printing 8
  - sRGB Display color correction 9
  - Standard print quality mode 8
  - streaks, ink 52
- supplies
- order information 1
- SWOP Press color correction 9

## T

- TekColor color corrections 9
- Toyo color correction 9

- transparencies
  - ordering information 2
  - printing from standard tray 24
  - printing from Transparency/Label Tray 27
  - printing manual feed 14
  - sizes 11
- transparency trays
  - ordering information 3
- trays
  - high capacity 27
  - loading 24
  - optional assembly 25
  - ordering information 3
  - standard 23
  - Transparency/Label Tray 27
- troubleshooting
  - light stripes, brief procedure 49
  - media jams 42
  - print quality problems (brief) 49
  - smears, ink 54
  - smears, oil or ink 51
  - streaks, ink 52

## V

- Vivid Color color correction 9



**Tektronix®**



Printed on recycled paper

0 7 1 - 0 6 4 3 - 0 0